

hayneedle 

1.888.880.4884

Assembly Instructions

ITEM Number : ALZ392-2

Product Name: Rubbed Bronze Scroll Fire Pit with Cover and Grill

PRE-ASSEMBLY PREPARATION:



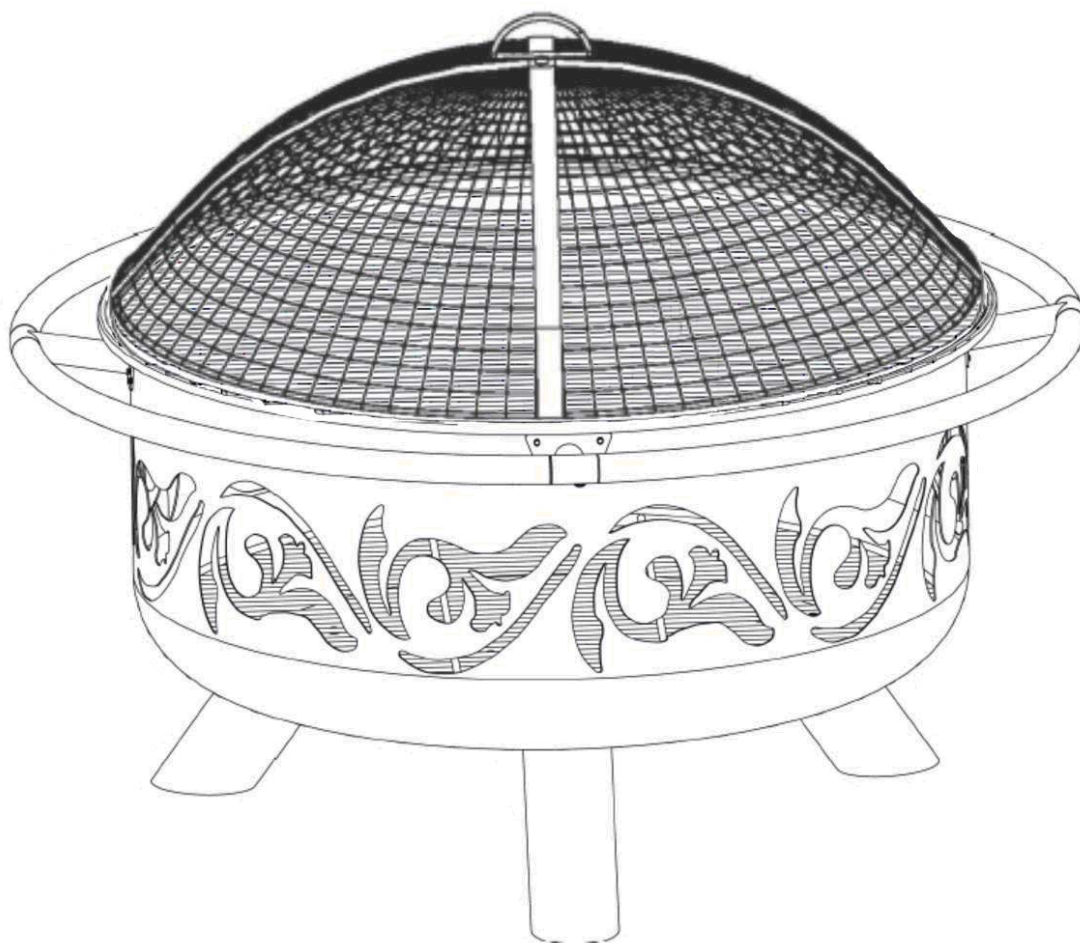





- Make sure all parts are included before assembly.
- Recommended two people to assemble the product.
- Warning: Small parts are contained. Keep away from children.







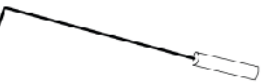

For Outdoor Use Only!

1. Improper installation, adjustment, alteration, service or maintenance can cause injury or property damage.
2. Read the assembly and operating instructions thoroughly before installing or servicing this equipment.
3. Failure to follow these instructions could result in fire or explosion, which could cause property damage, personal injury, or death.

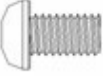
Hardware List

	PARTS	QTY
A		1PC
B		1PC
C		1PC
D		1PC
E		4PC
F		1PC
G		4PC
H		3PC
I		1PC
J		1PC

	PARTS	QTY
1	 	20PCS
2	 	9PCS
3	 	1PC
4	 	1PC

Assembly Instructions:

- ★ When applicable, tighten all hardware connections by hand first.
- ★ Once the step is completed, go back and fully tighten all hardware.
- ★ Follow all steps in order to properly assemble the product.

STEP 1: Attach legs to the bowl using bolt (2) 9pcs.

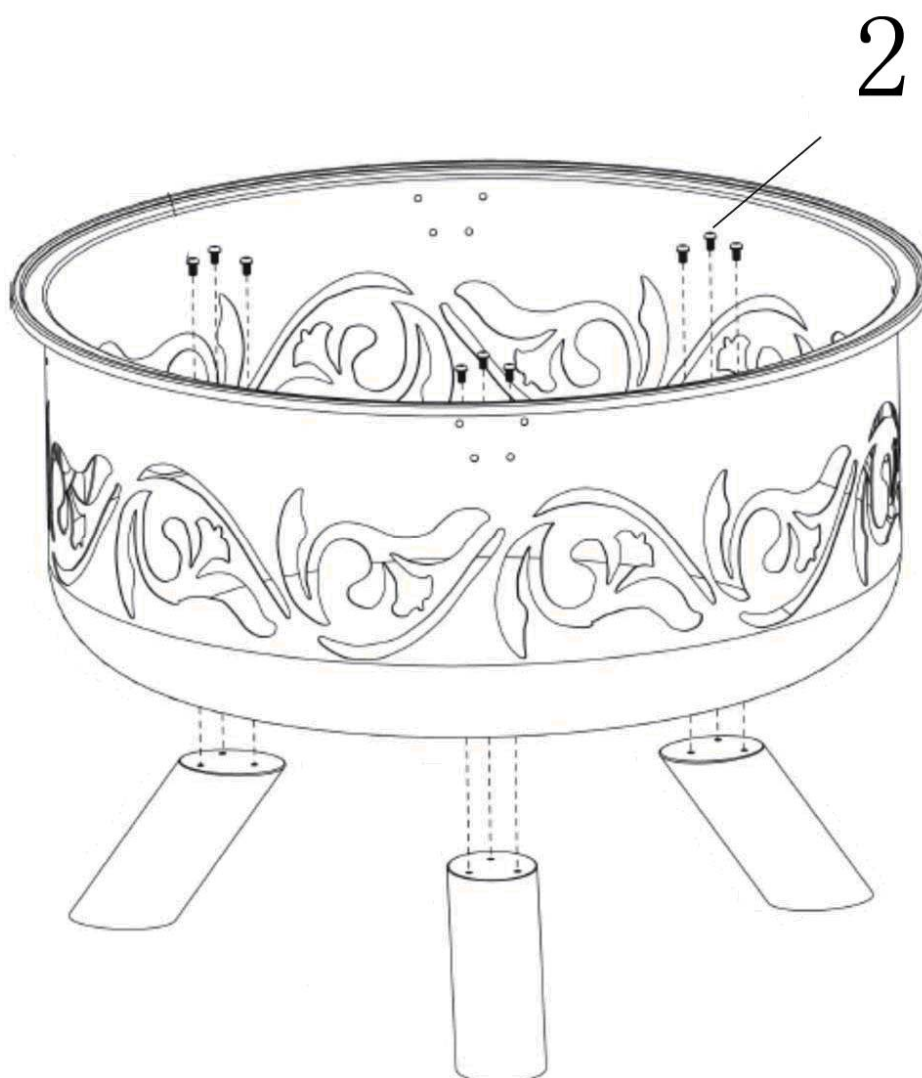

STEP 2: Attach base rings to the bowl using screw (1) 20pcs.

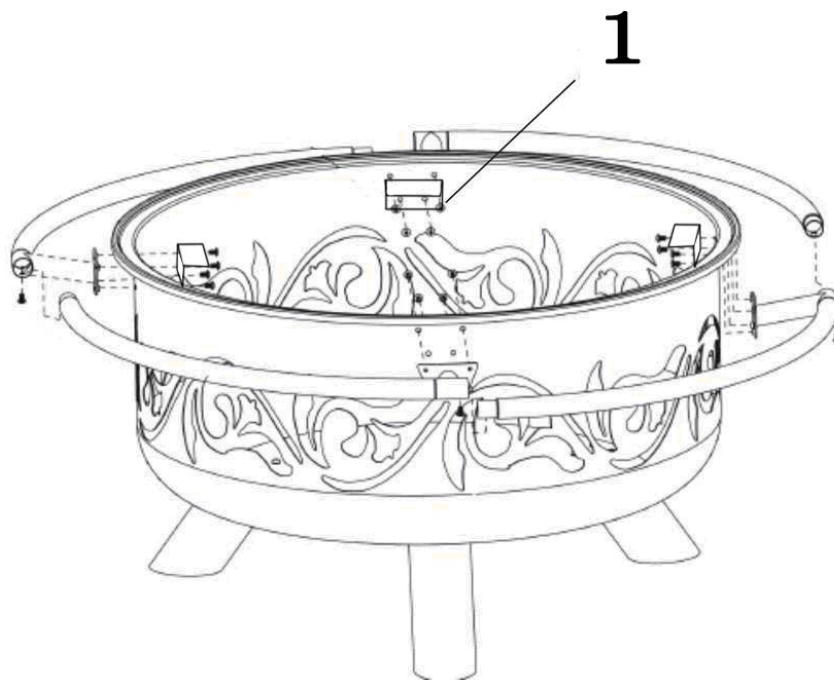

STEP 3: Attach Handle to the spark guard using nut (3) 1pc.

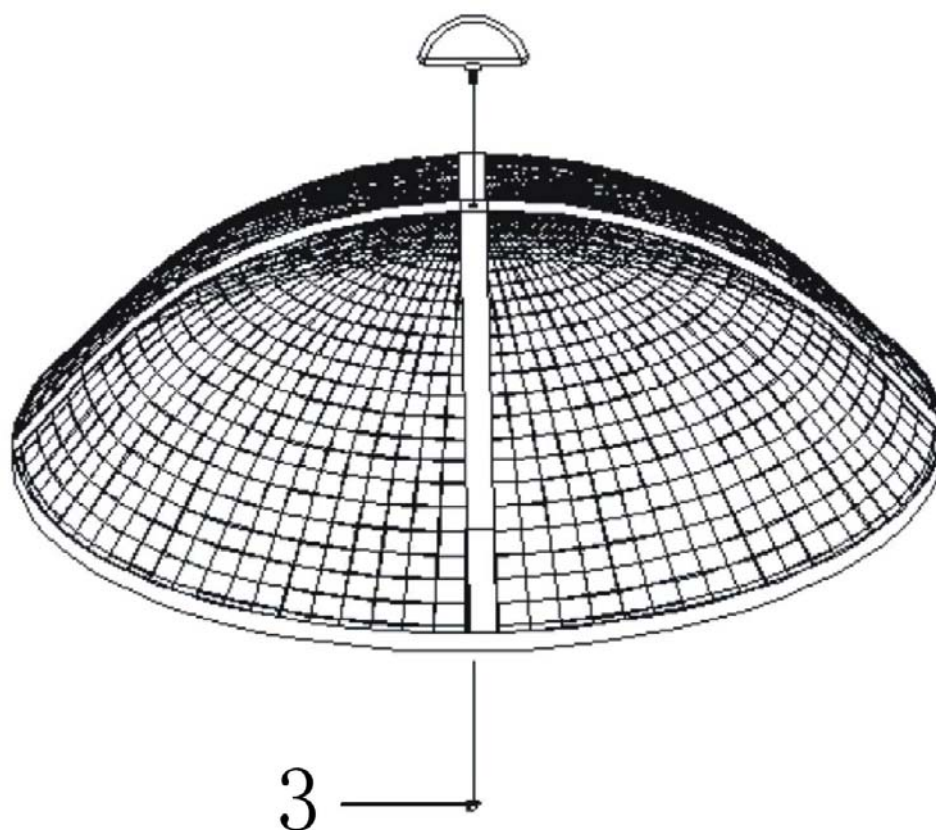

STEP 4: Insert wood grid and grill grate into the bowl. Set spark guard on top.

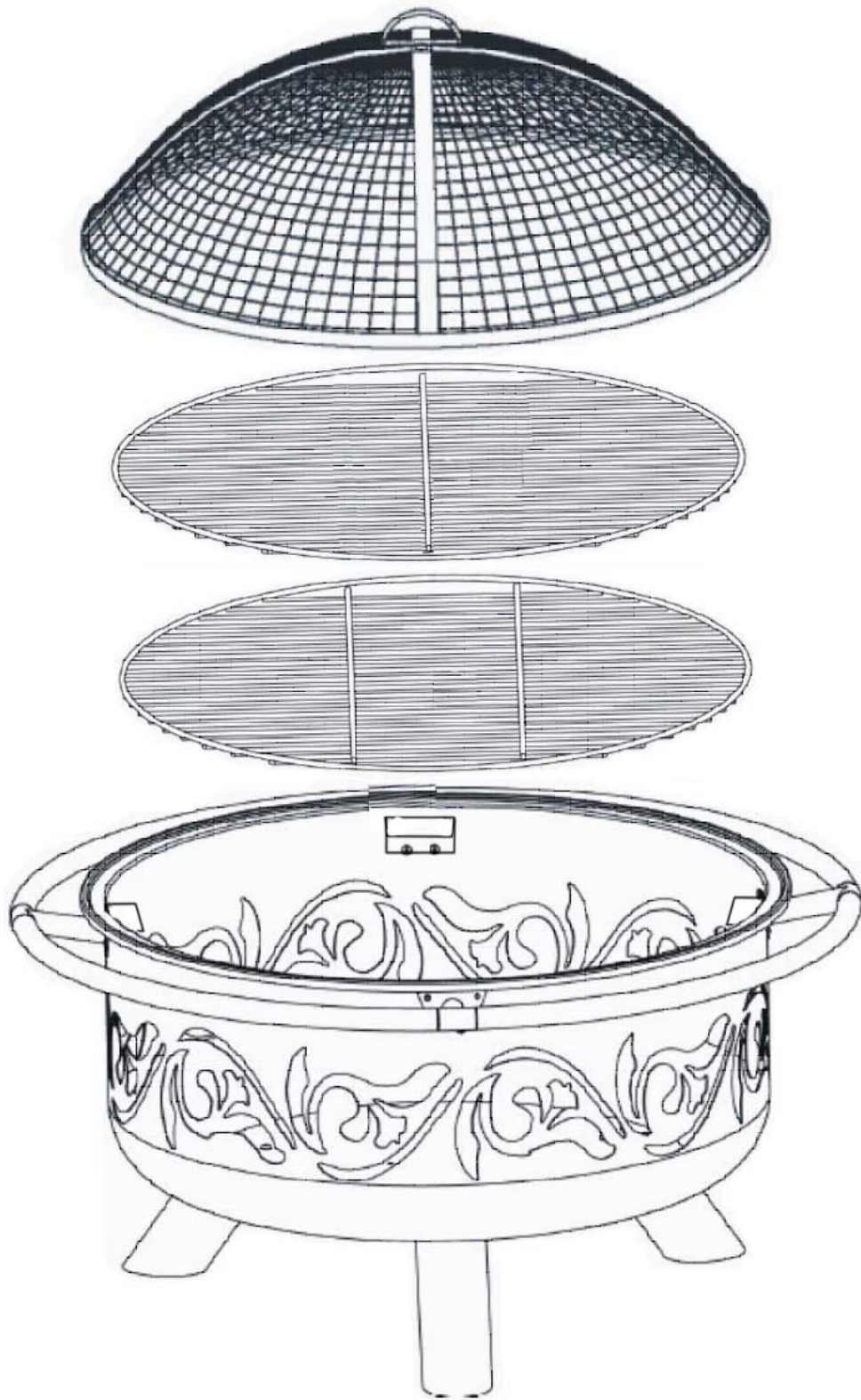

STEP 5: Completed.

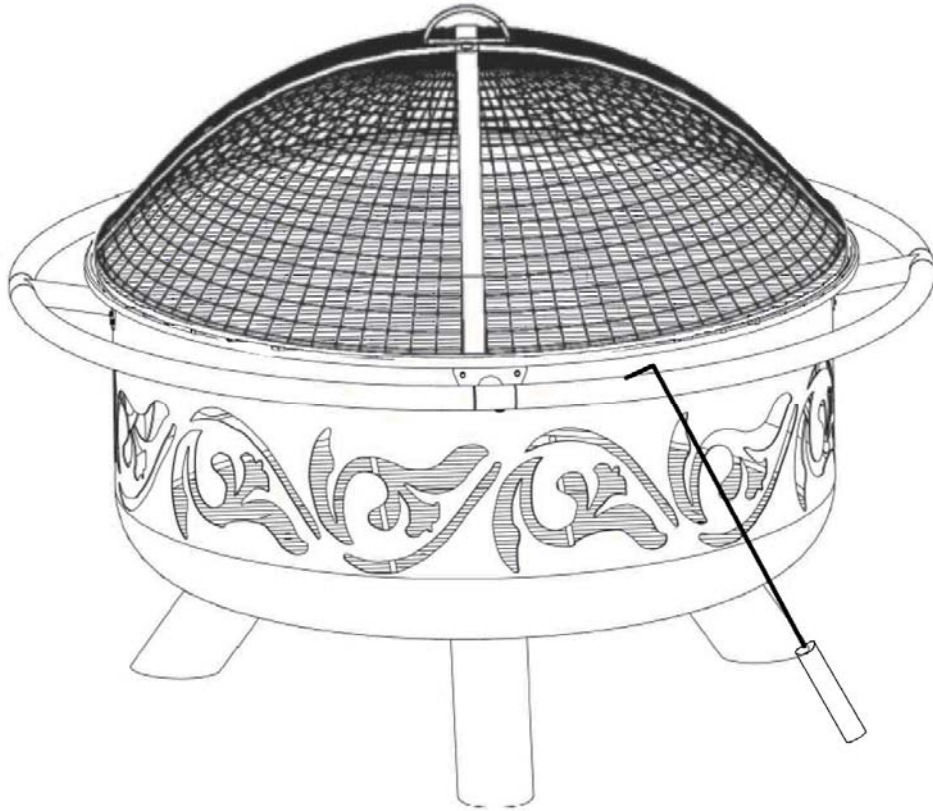

Note: Cover the outdoor fire pit with the enclosed cover when it is not in use.



WARNING

FOR YOUR SAFETY

1. This appliance is for outdoor use only, and shall NOT be used in a building, garage, or any other enclosed area.
2. Do NOT use this outdoor fireplace for indoor heating. TOXIC carbon monoxide fumes can accumulate and cause asphyxiation.
3. This is not intended for commercial use.
4. This outdoor fireplace is NOT to be operated by children.
5. Please do not use the fire pit on boats or recreational vehicles.
6. When using this outdoor fireplace, exercise the same precautions you would with any open fire.
7. The use of alcohol, prescription or non-prescription drug may impair the consumer's ability to properly assemble or safely operate this outdoor fireplace.
8. Do NOT use this outdoor fireplace without reading the entire "Instruction Manual".
9. This outdoor fireplace is for use with dry, seasoned hardwood. It will burn hotter, more completely and create less smoke.
10. Do NOT burn charcoal briquets, lump charcoal, manufactured logs, driftwood, trash, leaves, paper, cardboard, plywood, painted or stained or pressure treated wood. Avoid using softwoods such as pine or cedar that can throw sparks.
11. Do NOT alter this outdoor fireplace in any manner.
12. Do Not use this outdoor fireplace until it is COMPLETELY assembled and all parts are securely fastened and tightened.
13. Do NOT store or use gasoline or other flammable vapors or liquids in the vicinity of this or any other appliance.
14. Do NOT store or use an LP gas cylinder within 10 feet (3.05 m) of this outdoor fireplace while it is in operation.
15. Do NOT use this outdoor fireplace near automobiles, trucks, vans or recreational vehicles.
16. Do NOT use in an explosive atmosphere. Keep outdoor fireplace area clear and free from combustible materials, gasoline and other flammable liquids.
17. Do NOT use this outdoor fireplace under any overhead or near any unprotected combustible constructions. Avoid using near or under overhanging trees and shrubs.
18. Always use this outdoor fireplace on a hard, level non-combustible surface such a concrete, rock or stone. An asphalt or blacktop surface may not be acceptable for this purpose. Do NOT use on wooden decks.
19. Always empty this outdoor fireplace before each use.
20. Do NOT wear flammable or loose clothing when operating this outdoor fireplace.
21. Do NOT use in windy conditions.
22. Do NOT use this outdoor fireplace unless spark guards are securely in place.
23. Do NOT use gasoline, kerosene, diesel fuel, lighter fluid or alcohol to light or relight fires.
24. Keep all electrical cords away from a hot fireplace.
25. All surfaces of this outdoor fireplace are hot when in operation. To avoid burns, do NOT touch fireplace until it has completely cooled unless you are wearing protective gear (Potholders, gloves, BBQ mittens, hot pads & etc.). Never touch ashes or coals to see if they are hot.
26. Do NOT leave a lit outdoor fireplace unattended, especially around children and pets.
27. Do NOT attempt to move or store this outdoor fireplace until all ashes and coals are completely extinguished.
28. Do NOT remove ashes or coals until they are completely and fully extinguished.
29. Use heat-resistant gloves or hot pads when contacting handles.
30. Use long, sturdy fireplace tools when adding or moving logs.
31. Do NOT place wood directly into bottom of the outdoor fireplace. Place wood only on the wood grid.
32. Do NOT overload the fireplace. Do not add additional firewood until the fire burns down. NOTICE: If any portion of the bowl, lid or spark guards of this outdoor fireplace are glowing red it is overloaded.
33. Do NOT lean over this outdoor fireplace when lighting or when in use.
34. Do NOT place a hot spark guard or hot fireplace tools onto combustible surfaces such as grass, wooden deck or furniture.
35. Avoid breathing smoke from the fire and avoid getting it into your eyes.
36. This outdoor fireplace should be thoroughly inspected and cleaned on a regular basis.
37. After a period of storage and/or non-use, check for signs of damage and creosote build-up. Do NOT operate until necessary repairs and/or cleanup are executed.
38. Use only factory authorized parts. The use of any part that is NOT factory authorized can be dangerous.
39. Please use protective gloves when assembling this product.
40. Do not force parts together as this can result in personal injury or damage to the product.
41. Deaths, serious injury or damage to property may occur if the above is not followed exactly.

Operating Instructions

Lighting

1. Make sure there is no more than a small amount of ash in the bottom of the bowl.
2. Place a layer of dry kindling or a natural fire starter onto the center of the grate.
3. Place above that a layer of dry seasoned hardwood that is cut to lengths no more than 3/4 the diameter of the bowl.
4. Use a match to light kindling or fire starter.
5. Using a hook and heat resistant gloves, replace spark guard once the kindling or fire starter is lit.

Tending the Fire

You may need to shift and/or add logs for an ideal experience.

Do NOT place a hot spark guard or hot fireplace tools onto combustible surfaces such as grass, wooden deck or furniture.

1. Using a hook and heat resistant gloves, carefully remove spark guard.
2. While using a long handled fireplace tool, shift coals and logs to allow additional airflow.
3. Do NOT add gasoline, kerosene, diesel fuel, lighter fluid or alcohol to relight or enhance an existing fire.
4. Wait until glowing coals have developed before adding any additional wood. If additional wood is required, place wood on top coals. Be careful not to shift ashes.
5. Using a hook and heat resistant gloves, replace spark guard.

Extinguishing

1. Allow fire to burn itself out.
2. Do NOT use water to extinguish as this is dangerous and can cause damage to this outdoor fireplace.

Inspecting

This outdoor fireplace should be inspected on a regular basis to ensure product safety and longer product life.

Do NOT attempt to inspect this outdoor fireplace until the fire is COMPLETELY out.

1. Check handles to make sure they are secure.
2. Check components for any signs of damage or rust.
3. If damage to any component is detected, do NOT operate until repairs are executed.

Cleaning

This outdoor fireplace should be cleaned on a regular basis to promote safer experiences and longer product life.

Note: After repeated use, a slight discoloration of the finish may occur.

Do Not attempt to clean this outdoor fireplace until the fire is COMPLETELY out.

Do NOT use oven cleaner or abrasive cleaners as they will damage this product.

Do NOT clean any part of this outdoor fireplace in a self cleaning oven as it may damage the finish.

Do NOT use pressure washer to clean this outdoor fireplace, as this may damage this product.

1. Wipe exterior surfaces with a mild dishwashing detergent or baking soda.
2. For stubborn surfaces use a citrus based degreaser and a nylon scrubbing brush.
3. Rinse clean with water.
4. Remove built-up creosote from base, hood and spark guards with a chimney cleaning product.

Storage

Do NOT move or store this outdoor fireplace until the fire is COMPLETELY out.

1. Once the fire is out, coals are cold and outdoor fireplace is cool to the touch, remove ashes and properly dispose.
2. Cover the outdoor fire pit with the enclosed cover when it is not in use.
3. Store assembled in a location away from children and pets.